

TOOL KIT

The tool kit (1) is in the storage compartment (2) inside the left side cover (page 41).

Some roadside repairs, minor adjustments and parts replacement can be performed with the tools contained in the kit.

- 8 x 12 mm open end wrench
- 10 x 14 mm open end wrench
- Pliers
- 5 mm hex wrench
- No. 1 screwdriver
- No. 3 screwdriver
- Screwdriver grip
- 22 mm Eye wrench
- 27 mm Eye wrench
- Eye wrench handle
- Spark plug wrench
- Feeler gauge 0.7 mm
- Pin spanner
- Tool bag

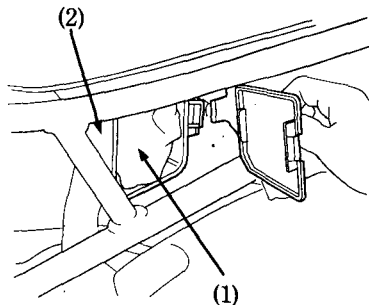

(1) Tool kit (2) Storage compartment